



Nel settore dell'arredo dal 1954, la società ha puntato sin dall'inizio sul binomio alta tecnologia e design, grazie alla sua flessibilità produttiva: BK GROUP è infatti una delle poche realtà a curare internamente l'intero ciclo di produzione del divano letto: dalla carpenteria, per la lavorazione delle parti metalliche necessarie alla realizzazione dei meccanismi, al reparto tappezzeria e a quello dedicato all'assemblaggio dei semilavorati. Nei laboratori di BK GROUP, inoltre, vengono realizzati anche tutti i prototipi progettati dagli architetti. Qualità, puntualità nelle consegne, forte attenzione all'etica (no al lavoro minorile e certificazioni di compatibilità ambientale) e posizione finanziaria solida sono poi le caratteristiche che hanno reso BK GROUP un punto di riferimento nel settore, sia sul mercato italiano che internazionale, in ambito privato e professionale.

Operating in the furniture sector since 1954, the company has bet on the combination of technology and design since the very beginning, thanks to its production flexibility. BK GROUP is, in fact, one of the few companies to manage the entire sofa bed production cycle: from the carpentry department, where the metal parts needed for the mechanisms are made, to the upholstery department, to the department where semi-finished items are assembled together. In addition, all the prototypes designed by architects are made in the BK GROUP laboratories. Quality, timely deliveries, strong focus on ethics (no exploitation of child labor and environmental compatibility certificates) and a solid financial position are the characteristics that have made BK GROUP a point of reference in the sector, on both the Italian and international market, in the private and professional sector.

Azienda Company





Corporate

progetto di ristrutturazione 2006 – 2008
Dante O. Benini & Partners Architects - Milano

graphic & corporate identity
Vignelli Associates – New York

fotografie fabbrica
Beppe Raso

fotografie prodotti
Amendolagine.Barracchia Studio

Corporate

*interior and facade restyling 2006 – 2008
Dante O. Benini & Partners Architects - Milano*

*graphic & corporate identity
Vignelli Associates – New York*

*photo company
Beppe Raso*

*photo products
Amendolagine.Barracchia Studio*



Carpenteria metallica

Reparto completo e flessibile che grazie all'esperienza degli addetti e ad un parco macchinari sempre aggiornato permette la lavorazione e la produzione di tutte le parti metalliche necessarie alla realizzazione dei meccanismi di trasformazione divano-letto, garantendo anche la possibilità di realizzare telai di nuova concezione (prototipi studiati e progettati dall'ufficio interno di ricerca e sviluppo) e di mettere in produzione meccanismi di misure speciali richieste dal cliente. Il reparto è suddiviso nelle seguenti fasi di lavorazione: **taglio, tranciatura, grassaggio, saldatura, verniciatura, assemblaggio, controllo qualità** previsto al termine di ogni singola fase, dall'acquisizione della materia prima al prodotto finito della carpenteria.

Metal carpentry

*Complete and flexible department in which, thanks to the experience of its staff and constantly updated equipment, the machining and production of all metal parts needed to make the sofa-bed conversion mechanism are carried out. The department also guarantees the possibility to manufacture new frames (prototypes studied and designed by the company's own research and development office) and to put in production mechanisms with special sizes requested by the customer. The department is divided into the following phases: **cutting, shearing, degreasing, welding, painting, assembly, quality control** carried out at the end of each single phase, from the acquisition of raw materials to the finished carpentry product.*



Tappezzeria

Reparto che comprende tutte le fasi di lavorazione per il confezionamento dei divani: **taglio automatico** con macchina a controllo numerico; **taglio manuale** per tipologie di tessuto particolari; **sorfilo, cucito** con tavoli personalizzati; **messa in bianco** con utilizzo di poliuretano espanso fornito da aziende produttrici che garantiscono l'assenza di clorofluorocarburi (C.F.C.) e, su richiesta del cliente, di materiali speciali con caratteristiche di elevata resistenza all'infiammabilità; montaggio, utilizzo di tavoli ergonomici e di postazioni flessibili in funzione del tipo di assemblaggio; **rivestimento** fase affidata all'abilità artigianale di manodopera specializzata ed esperta; **controllo qualità** che garantisce l'esclusività del prodotto fatto in Italia.

Upholstery

*Department including different phases: **automatic cutting** with CNC machine; **manual cut** for special types of fabrics; **overcasting and sewing**, equipped with personalized tables; **pre-upholstery** - use of foam polyurethane supplied by manufacturing companies that guarantee the absence of chlorofluorocarbons (C.F.C.), upon the customer's request, supply of special materials with high resistance to flammability; **lining assembly** - use of ergonomic tables and flexible stations depending on the type of assembly to be carried out; **quality control** which guarantees the prerogative of a made in Italy product.*



Home Interior

Al mercato privato, BK ITALIA dedica una linea di divani particolarmente curati sia dal punto di vista dell'estetica che della funzionalità. Sempre più, infatti, le moderne scelte architettoniche privilegiano ambienti su misura, dove lo spazio giorno molto spesso viene condiviso con quello notte. In questi contesti, i divani e le poltrone letto di BK ITALIA rappresentano non solo un elemento di modernità e alto design, ma consentono anche di sfruttare al massimo lo spazio, associando caratteristiche d'uso semplici per l'utilizzo quotidiano al grande confort nel riposo serale.

Home Interior

BK ITALIA dedicates a very nice line of sofas to the private sector, characterised by nice aesthetics and high functionality. Indeed, more and more often modern architectural choices lean towards customised structures, where the living space is often used also for sleeping. In these situations, BK ITALIA's convertible sofa and armchair beds are not only a modern, finely designed element, but they also allow people to obtain maximum exploitation of space, associating its characteristic simplicity of use during the day with a considerable comfort for sleeping.



Professional market

Si sono affidati alla qualità italiana dell'azienda di Treviglio grandi catene alberghiere come il gruppo Accor, multinazionale francese nel settore alberghiero e nei servizi (presente in 140 paesi con 4 mila hotel). Ad Accor, in particolare, BK ITALIA fornisce l'arredo delle stanze con la fornitura di divani letto su misura, che tengono conto delle diverse esigenze richieste da ciascun albergo della catena - Novotel, Mercure, Sofitel, Suitehotel, Ibis. Tra gli ultimi accordi ci sono anche All Season, Holiday Inn, Marriot e Sheraton. Nel periodo 2003-2013 BK ITALIA ha fornito oltre 600 hotel in tutto il mondo.

Professional market

BK ITALIA is supply partner for sofa beds of great hotel chains such as the Accor Group, a French multinational corporation in the hospitality and services sector (present in 140 countries with 4 thousand hotels). Accor, in particular, asks BK ITALIA to supply the furnishings for their hotel rooms, with customised sofa beds that take into account the most diverse requirements of each hotel of the chain - Novotel, Mercure, Sofitel, Suitehotel, Ibis - . Among the latest agreements are those with All Season, Holiday Inn, Marriot and Sheraton. From 2003 to 2013 BK ITALIA has supplied more than 600 hotels all over the world.

Realizzazioni 2003-2014 - Projects 2003-2014

Africa	Africa	17
America	America	6
Asia	Asia	13
Europa	Europe	578
Oceania	Oceania	1
Totale	Total	615

Ultime realizzazioni 2003-2014 - Latest projects

Snowworld Hotel - Landgraaf (Holland) ****	43 divani letto / sofa beds	Ottobre / October 2014
Elysium Hotel - Paphos (Cyprus) *****	30 divani letto / sofa beds, 17 pouf	Giugno / June 2014
Hotel Du Golf Barriere - Deauville (France) ****	24 divani letto / sofa beds	Maggio / May 2014
Ibis 3 Lacs Neuchatel - Neuchatel-thielle (Switzerland)	29 divani letto / sofa beds	Marzo / March 2014

1927

La società **Tréfileries Leon Bekaert**, una delle più grandi trafileterie di ferro del mondo fondata nel 1880 da Leo Leander Bekaert a Zwevegem in Belgio, inizia la produzione di materassi a molle.

Tréfileries Leon Bekaert, a world market and technology leader in steel wire transformation and coatings, founded by Leo Leander Bekaert in 1880 in Zwevegem, Belgium, starts the production of spring mattresses.

BEKAERT



Leo Leander Bekaert

1935

Nasce il marchio **Beka**®, divisione della società **Tréfileries Leon Bekaert** che, con questo marchio, produce lana d'acciaio per la pulizia delle stoviglie e inoltre a Ruisbroek in Belgio avvia la produzione di molle per i materassi.

Brand Beka® is born as a division of Tréfileries Leon Bekaert. With this brand it is engaged in the production of steel wool. Moreover, it starts the production of springs for mattresses in Ruisbroeck, Belgium



1936

Il marchio **Beka**® immette nel mercato i primi materassi con il nuovo logo dei tre gattini.

Brand Beka® puts on the market mattresses with a new logo.



1954

La società **Tréfileries Leon Bekaert**, apre in Italia la nuova azienda **FIBLA Spa** (Fabbrica Italo-Belga Lane d'Acciaio) a Isola del Cantone (Genova) per la produzione di paglia di acciaio per la pulizia delle stoviglie, di molle per materassi e meccanismi per divani letto.

Tréfileries Leon Bekaert sets up a new company in Italy, Fibla Spa (Fabbrica Italo-Belga Lane d'Acciaio – Italian & Belgian Steel Wool Company) in Isola del Cantone (Genoa). It is specialized in the production of steel wool, springs mattresses and sofa bed mechanisms.



1963

Costruzione dello stabilimento in Treviglio - il secondo in piedi da sinistra è Giovanni Battista Vangelisti, tra i fondatori di **Bicappa Italia spa**.

The factory in Treviglio. Back row (2nd from the left) Giovanni Battista Vangelisti, one of the founders of the new company Bicappa Italia spa.



1964

La nuova società italiana **Leon Bekaert spa** porta a compimento la costruzione del nuovo stabilimento di circa 12.000 mq a Treviglio in provincia di Bergamo programmando una nuova attività di produzione di materassi a molle, divani e divani trasformabili in letto con il marchio **Beka Italia**®, sfruttando il know-how dell'azienda madre e trasferendo una parte del personale da Isola del Cantone a Treviglio.

The new Italian company Leon Bekaert spa decides to build a 12,000 square meters factory in Treviglio, near Bergamo. The idea is to start a new activity for the production of spring mattresses, sofas and sofa beds with the new brand Beka Italia®, exploiting the know-how of the mother company and moving employees from Isola del Cantone to Treviglio.



1977

La **Leon Bekaert spa** chiude e i dirigenti, tra cui Giovanni Battista Vangelisti, decidono di investire la propria liquidazione acquisendo l'attività e dando vita alla **Bicappa Italia spa**, specializzata nella produzione di materassi a molle e divani-letto per il mercato italiano.

Leon Bekaert spa decides to close down and its executives, including Giovanni Battista Vangelisti, invest their settlement buying all the assets. Bicappa Italia spa is officially born, and it is engaged in the production of spring mattresses, sofas and sofa beds for the Italian market.



2006

Si apre un nuovo corso. L'azienda, che opera oramai in tutto il mercato europeo, diventa **BK Italia spa**. La nuova immagine è curata dal designer di fama mondiale Massimo Vignelli, da Dante Oscar Benini, importante architetto italiano e dall'architetto Denise Viviani. Dante Oscar Benini progetta anche la ristrutturazione dell'intero stabilimento.

The company embarks on a new course. It now operates throughout the European market and becomes BK Italia spa. Massimo Vignelli, the world renowned designer, Dante Oscar Benini, an important Italian architect, and architect Denise Viviani take care of the new image of the company. Dante Oscar Benini also designs the restructuring of the factory.



2013

La società si rinnova e nasce **BK Group srl** che consolida la presenza nel mercato europeo ed extraeuropeo (Australia, Russia, Usa) e si apre ai nuovi mercati emergenti (Medio Oriente, Cina e India).

The company renews its organization in BK Group srl. It consolidates the European market while the Australian, Russian and USA markets increase. Moreover BK GROUP has new business opportunities in the emerging countries (Middle East, China, India).

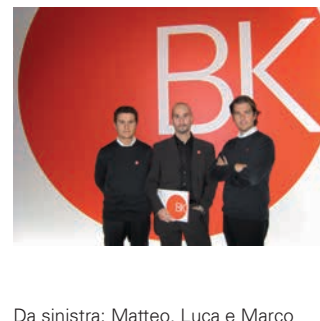

Da sinistra: Matteo, Luca e Marco Vangelisti: tre fratelli alla guida della società.

2001

Nuovo brand **BelliKomodi**®
New brand **BelliKomodi**®



Left to right: Matteo, Luca and Marco Vangelisti, three brothers at the head of the company.

Divani fissi o con letto
Sofas with or without bed

Divani letto a scorrimento
Sliding sofa-beds

Divani letto singolo e pouf
Single sofa bed and pouf

BK 101

BK 124

BK 109

BK 102

BK 128

BK 110

BK 103

BK 129

BK 111

BK 104

BK 112

BK 105

BK 113

BK 106

BK 114

BK 107

BK 115

BK 108

BK 116 pouf

BK 117

BK 116 poltrona

BK 118

BK 125

BK 119

BK 119 B

BK 123 Cesta-Nastro-Tessuto

BK 126 Special

BK 126

BK 127





BK ITALIA

Convertibles

**Trasformabile
BK 101**



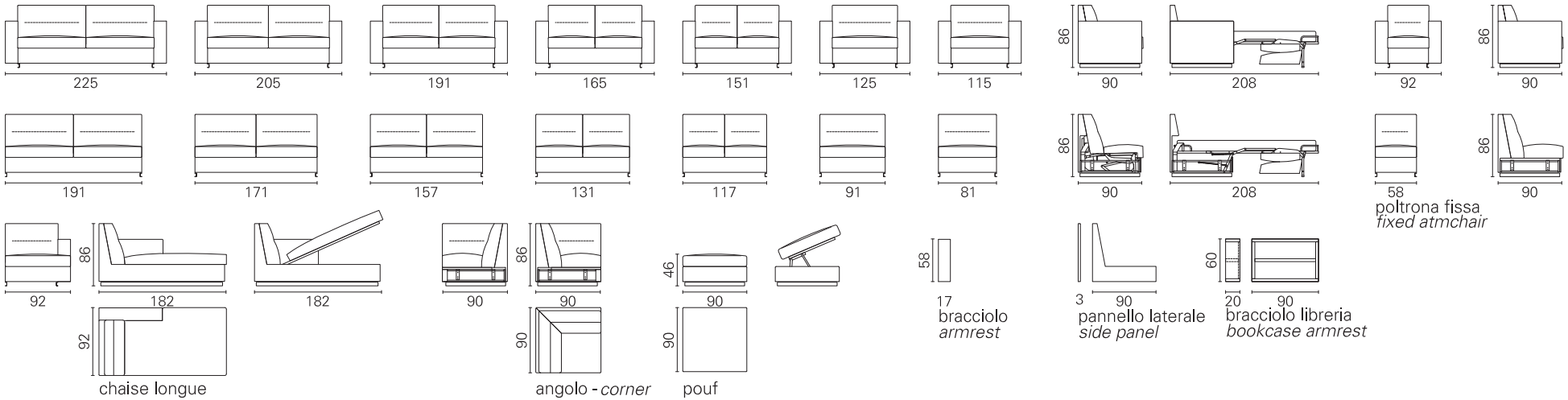

BK 101

Meccanismo
Mechanism
Cube

Materasso
Mattress
Boss

Misura
Size

cm 176 x 195	225
cm 156 x 195	205
cm 142 x 195	191
cm 116 x 195	165
cm 102 x 195	151
cm 77 x 195	125
cm 67 x 195	115









BK ITALIA

Convertibles

Trasformabile
BK 102



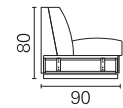
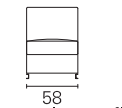
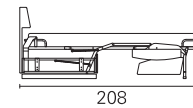
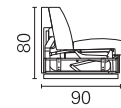
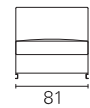
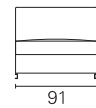
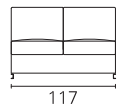
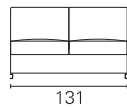
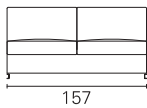
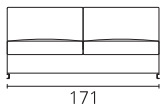
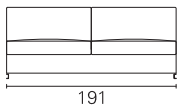
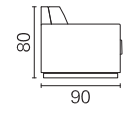
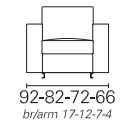
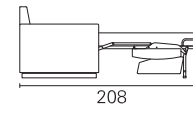
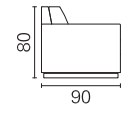
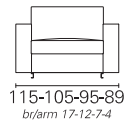
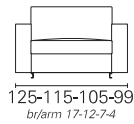
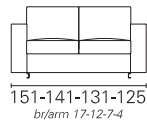
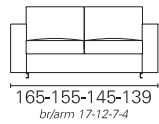
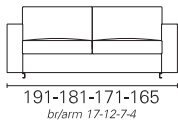
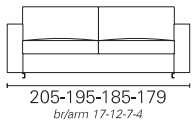
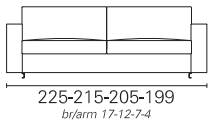

poltrona fissa
fixed armchair

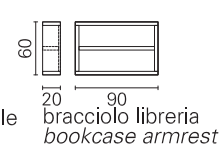
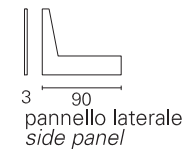
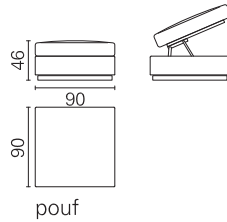
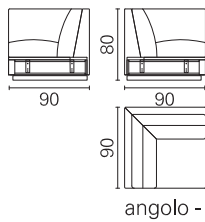
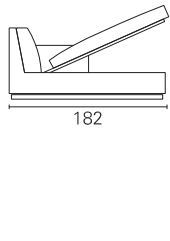
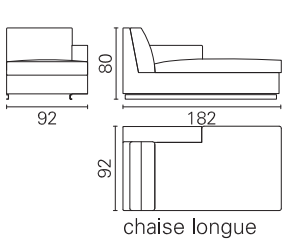

chaise longue

angolo - corner

pouf

bracciolo
armrest

pannello laterale
side panel

bracciolo libreria
bookcase armrest

BK 102

Meccanismo
Mechanism
Cube

Materasso
Mattress
Boss

Misura
Size

cm 176 x 195
cm 156 x 195
cm 142 x 195
cm 116 x 195
cm 102 x 195
cm 77 x 195
cm 67 x 195

225
205
191
165
151
125
115





BK ITALIA

Convertibles

Trasformabile

BK 103

Vignelli Design



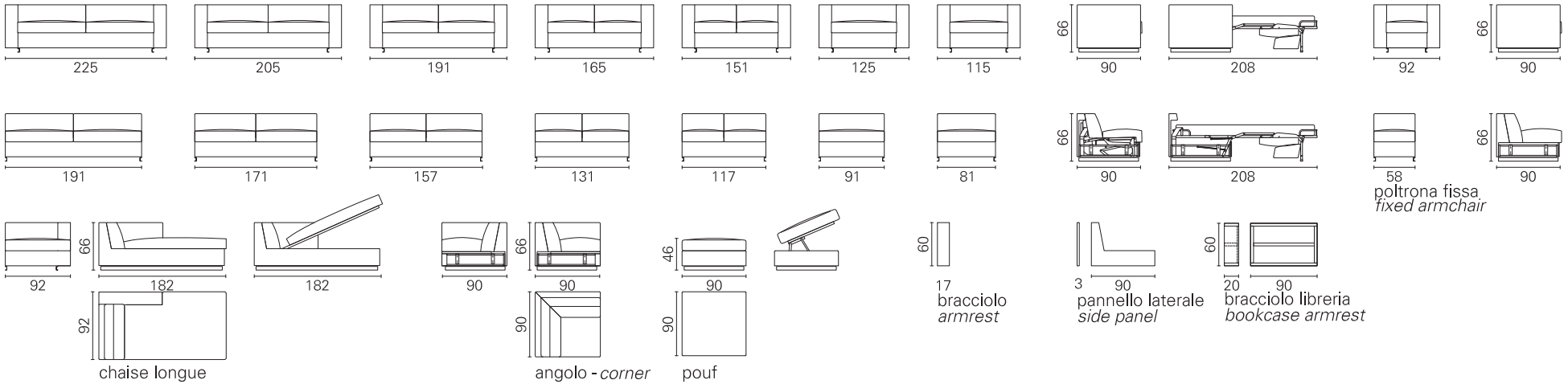

BK 103

Vignelli Design

Meccanismo
Mechanism
Cube

Materasso
Mattress
Boss

Misura
Size

cm 176 x 195	225
cm 156 x 195	205
cm 142 x 195	191
cm 116 x 195	165
cm 102 x 195	151
cm 77 x 195	125
cm 67 x 195	115





BK ITALIA

Convertibles

Trasformabile

BK 103 Schienale Reclinabile

Vignelli Design



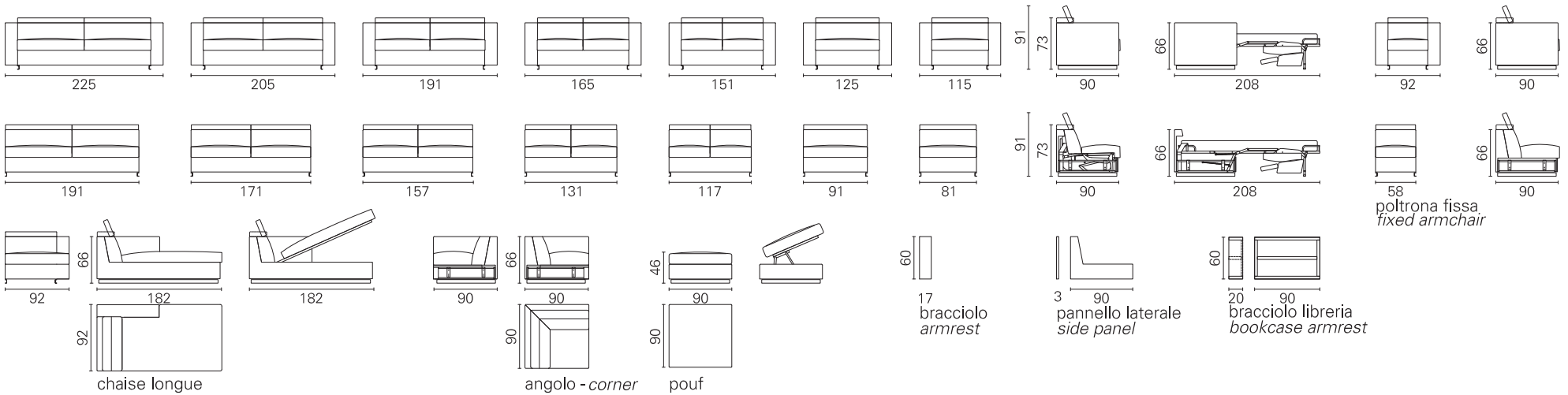

BK 103 Schienale Reclinabile

Vignelli Design

Meccanismo
Mechanism
Cube

Materasso
Mattress
Boss

Misura
Size

cm 176 x 195	225
cm 156 x 195	205
cm 142 x 195	191
cm 116 x 195	165
cm 102 x 195	151
cm 77 x 195	125
cm 67 x 195	115

BK ITALIA

Convertibles

BK 103 Schienale Reclinabile

Dettagli / Details

Vignelli Design





Wenge



Noce / *Walnut*



Rovere / *Oak*



Ciliegio / *Cherry*



BK ITALIA

Convertibles

Trasformabile

BK 104

Vignelli Design



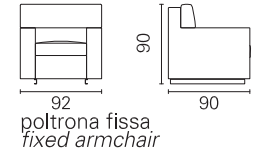
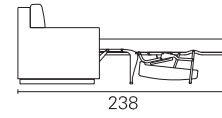
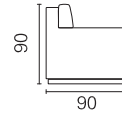
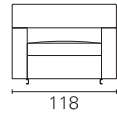
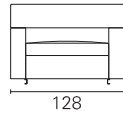
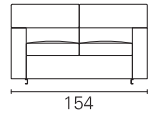
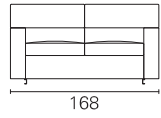
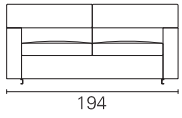
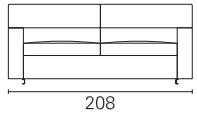

BK 104

Vignelli Design

Meccanismo
Mechanism
Starlet

Materasso
Mattress
Boss

Misura
Size

cm 176 x 195
cm 156 x 195
cm 142 x 195
cm 116 x 195
cm 102 x 195
cm 77 x 195
cm 67 x 195

228
208
194
168
154
128
118



BK ITALIA

BK ITALIA

BK ITALIA

BK ITALIA

BK ITALIA

Convertibles

**Trasformabile
BK 105**



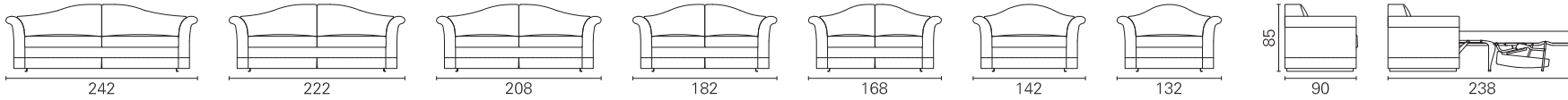

BK 105

Meccanismo
Mechanism
Starlet

Materasso
Mattress
Boss

Misura
Size

cm 176 x 195
cm 156 x 195
cm 142 x 195
cm 116 x 195
cm 102 x 195
cm 77 x 195
cm 67 x 195

242
222
208
182
168
142
132

BK ITALIA

Convertibles

Trasformabile
BK 106



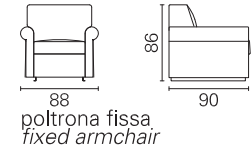
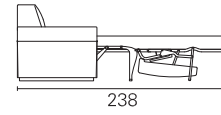
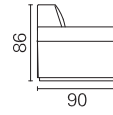
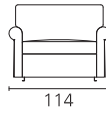
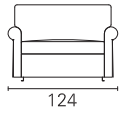
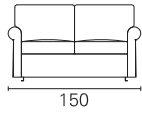
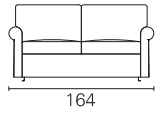
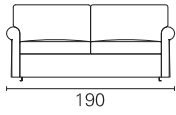
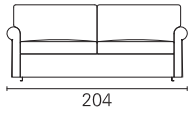
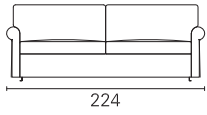

BK 106

Meccanismo
Mechanism
Starlet

Materasso
Mattress
Boss

Misura
Size

cm 176 x 195
cm 156 x 195
cm 142 x 195
cm 116 x 195
cm 102 x 195
cm 77 x 195
cm 67 x 195

224
204
190
164
150
124
114



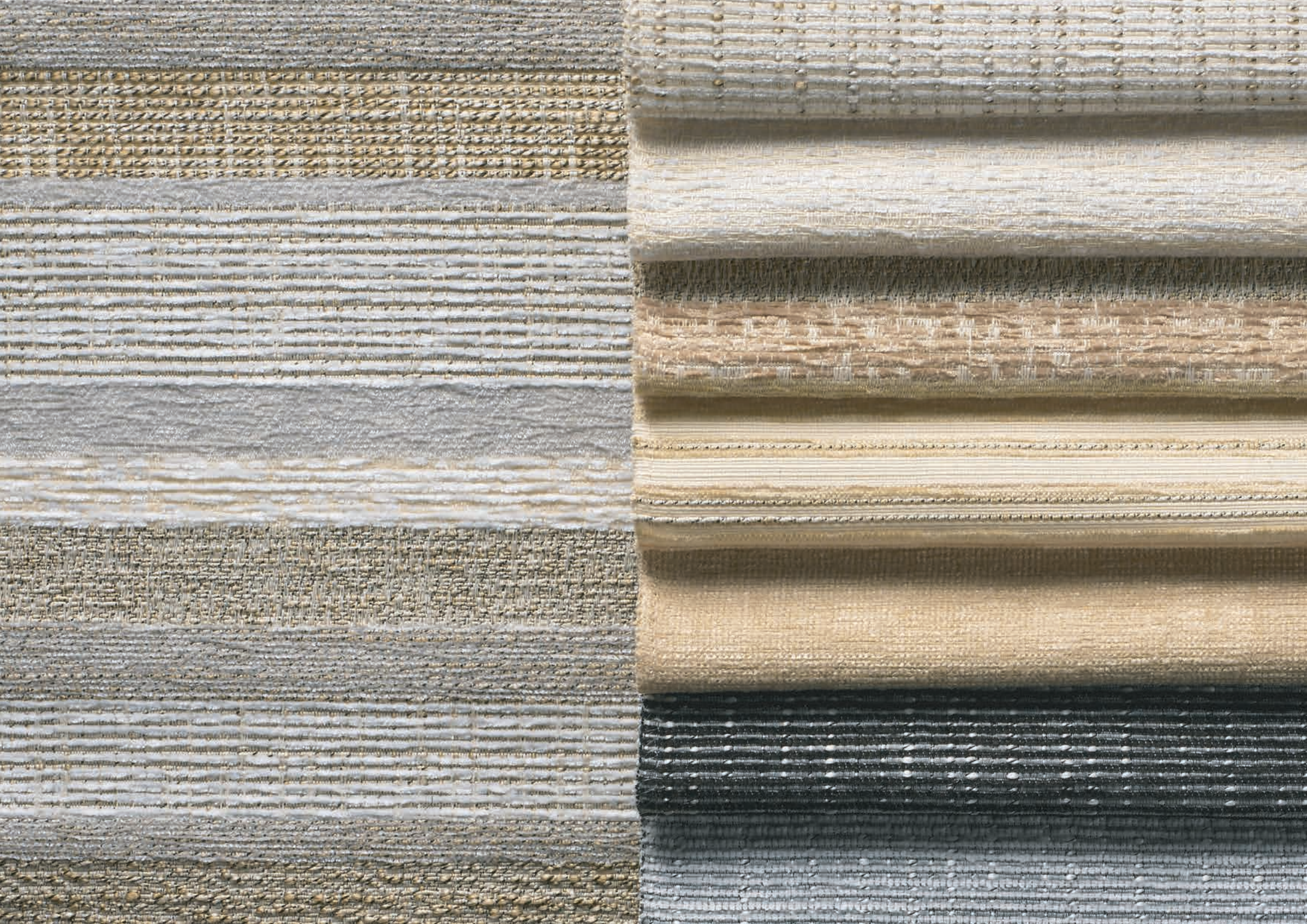

BK ITALIA

Convertibles

**Trasformabile
BK 107**



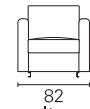
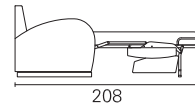
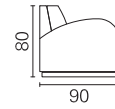
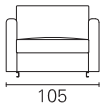
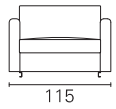
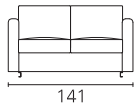
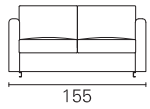
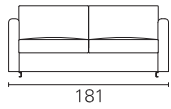
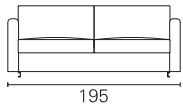
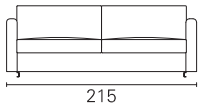

poltrona fissa
fixed armchair

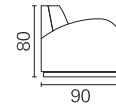

BK 107

Meccanismo
Mechanism
Cube

Materasso
Mattress
Boss

Misura
Size

cm 176 x 195
cm 156 x 195
cm 142 x 195
cm 116 x 195
cm 102 x 195
cm 77 x 195
cm 67 x 195

215
195
181
155
141
115
105

BK ITALIA

Convertibles

Trasformabile
BK 108



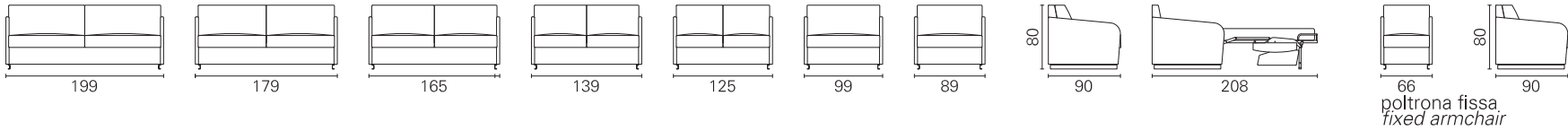

BK 108

Meccanismo
 Mechanism
Cube

Materasso
 Mattress
Boss

Misura
 Size

cm 176 x 195	199
cm 156 x 195	179
cm 142 x 195	165
cm 116 x 195	139
cm 102 x 195	125
cm 77 x 195	99
cm 67 x 195	89

BK ITALIA

Convertibles

Trasformabile
BK 109

Agape Studio design



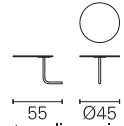
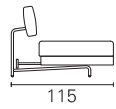
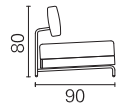
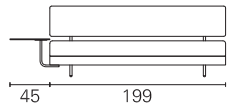
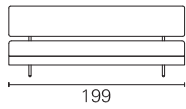

tavolino piano bianco
table white top

BK 109

Agape Studio design

Meccanismo
Mechanism
Matrix

Materasso
Mattress
Matrix

Misura
Size

cm 85 x 195

cm 85 x 195 memory foam

195

195



BK ITALIA

BK ITALIA

BK ITALIA



BK ITALIA

Convertibles

**Trasformabile
BK 110**



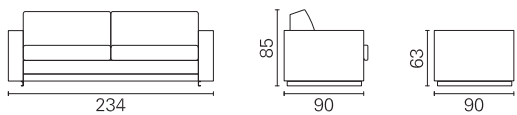

BK 110

Meccanismo
Mechanism
Retrò

Materasso
Mattress
Retrò

Misura
Size

cm 80 x 187

234

BK ITALIA

Convertibles

**Trasformabile
BK 111**



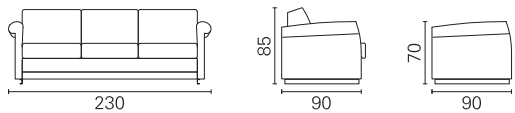

BK 111

Meccanismo
Mechanism
Retrò

Materasso
Mattress
Retrò

Misura
Size

cm 80 x 187

230

BK ITALIA

Convertibles

**Trasformabile
BK 112**



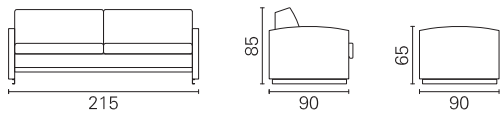

BK 112

Meccanismo
Mechanism
Retrò

Materasso
Mattress
Retrò

Misura
Size

cm 80 x 187

215





BK ITALIA

Convertibles

Trasformabile

BK 113

Vignelli Design



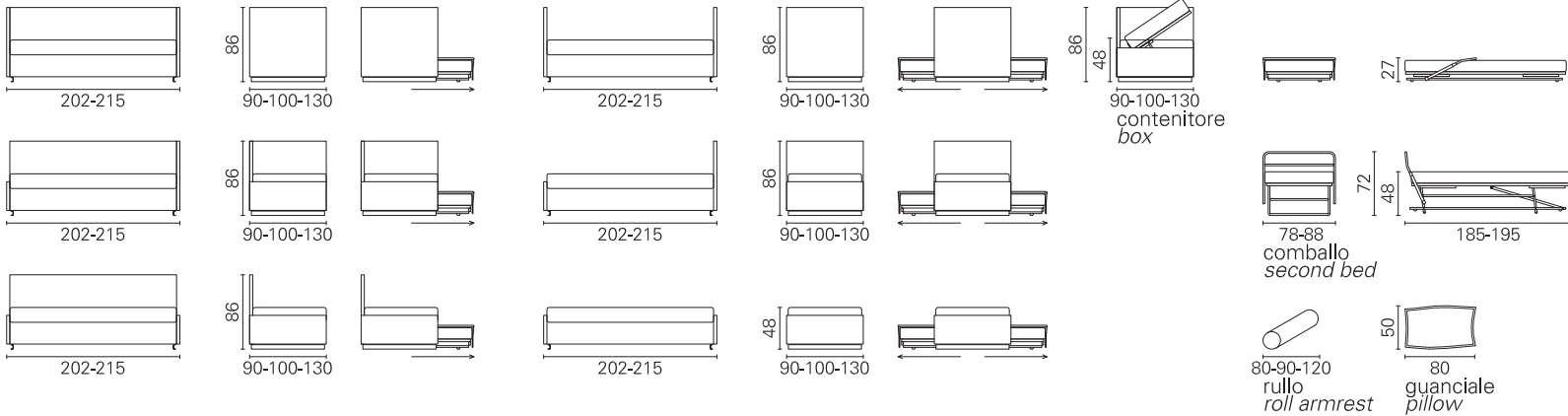

BK 113

Vignelli Design

Meccanismo
Mechanism
Angelo

Meccanismo rete inferiore
Second bed Mechanism
Comballo

Materasso
Mattress
Caravaggio superiore

cm 120 x 200 - cm 120 x 187
cm 90 x 200 - cm 90 x 187
cm 80 x 200 - cm 80 x 187

Materasso
Mattress
Caravaggio inferiore

cm 75 x 195
cm 75 x 185
cm 85 x 195
cm 85 x 185

BK ITALIA

Convertibles

**Trasformabile
BK 114**



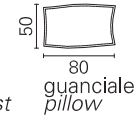
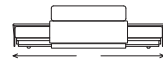
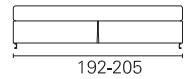
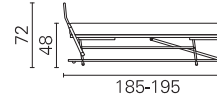
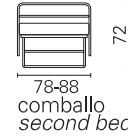
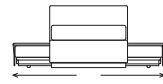
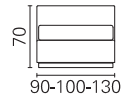
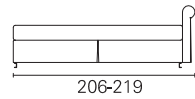
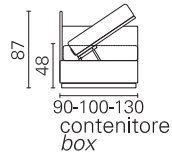
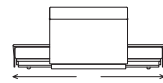
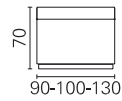
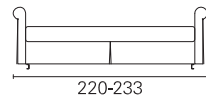
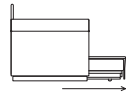
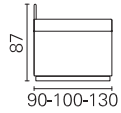
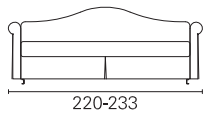

BK 114

Meccanismo
Mechanism
Angelo

Meccanismo rete inferiore
Second bed Mechanism
Comballo

Materasso
Mattress
Caravaggio superiore

cm 120 x 200 - cm 120 x 187
cm 90 x 200 - cm 90 x 187
cm 80 x 200 - cm 80 x 187

Materasso
Mattress
Caravaggio inferiore

cm 75 x 195
cm 75 x 185
cm 85 x 195
cm 85 x 185

BK ITALIA

Convertibles

Trasformabile
BK 114





BK ITALIA

Convertibles

**Trasformabile
BK 115**



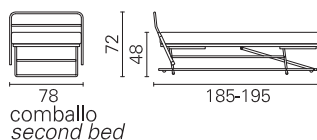
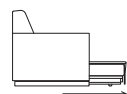
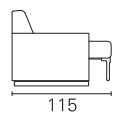
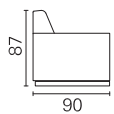
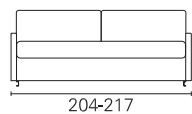

comballo
second bed

BK 115

Meccanismo
Mechanism
America

Meccanismo rete inferiore
Second bed Mechanism
Comballo

Materasso
Mattress
Caravaggio superiore

cm 80 x 200
cm 80 x 187

Materasso
Mattress
Caravaggio inferiore

cm 75 x 195
cm 75 x 185

Misura
Size

217
204

217
204

BK ITALIA

Convertibles

**Trasformabile
BK 116 pouf**



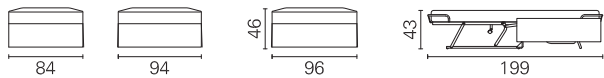

BK 116 pouf

Meccanismo
Mechanism
Poufletto

Materasso
Mattress
Poufletto

Misura
Size

cm 78 x 190
cm 68 x 190

94
84

BK ITALIA

Convertibles

**Trasformabile
BK 116 poltrona**



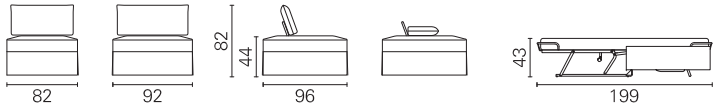

BK 116 poltrona

Meccanismo
Mechanism
Poufletto

Materasso
Mattress
Poufletto

Misura
Size

cm 78 x 190
cm 68 x 190

92
82

BK ITALIA

Convertibles

**Trasformabile
BK 117**



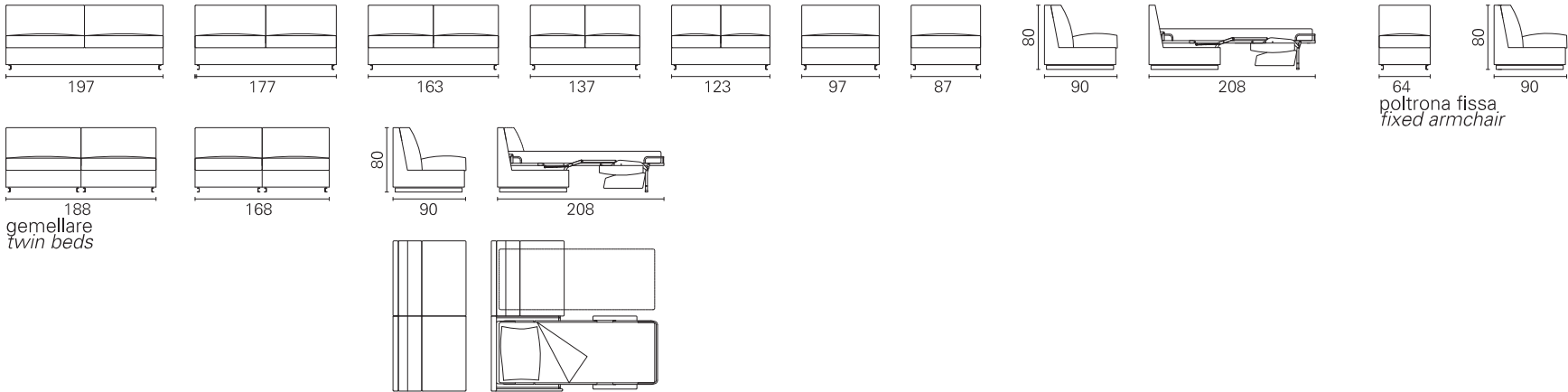

BK 117

Meccanismo
Mechanism
Cube

Materasso
Mattress
Boss

Misura
Size

cm 176 x 195	197	
cm 156 x 195	177	
cm 142 x 195	163	
cm 116 x 195	137	
cm 102 x 195	123	
cm 77 x 195	97	188 n°2
cm 67 x 195	87	168 n°2



BK ITALIA

BK ITALIA

BK ITALIA

BK ITALIA



BK ITALIA

Convertibles

Trasformabile

BK 118

Vignelli Design



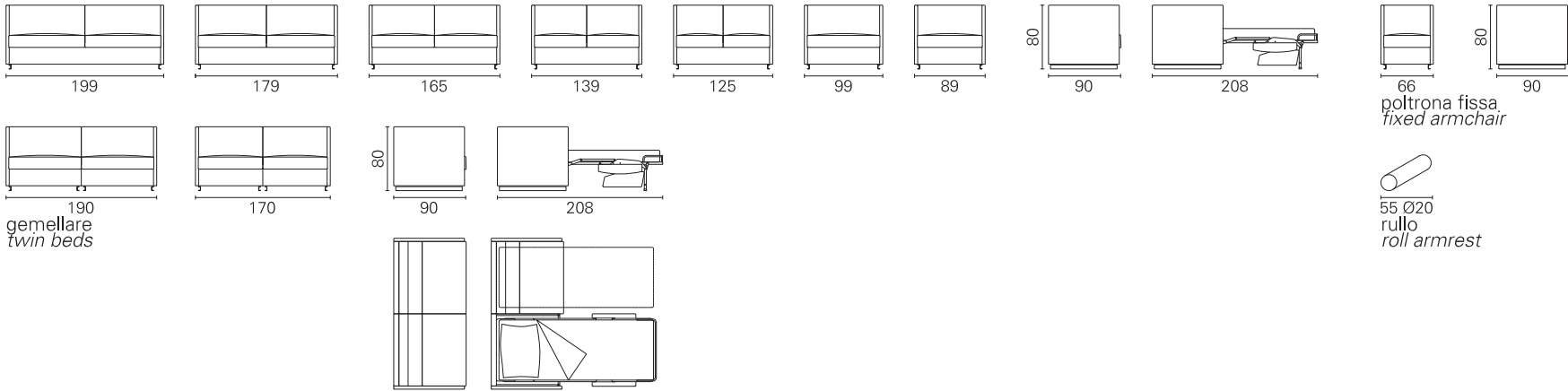

BK 118
Vignelli Design

Meccanismo
Mechanism
Cube

Materasso
Mattress
Boss

Misura
Size

cm 176 x 195	199	
cm 156 x 195	179	
cm 142 x 195	165	
cm 116 x 195	139	
cm 102 x 195	125	
cm 77 x 195	99	190 n°2
cm 67 x 195	89	170 n°2



BK ITALIA

BK ITALIA

BK ITALIA



BK ITALIA

Convertibles

Trasformabile

BK 119

Vignelli Design



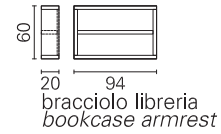
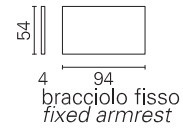
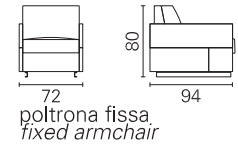
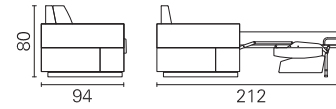
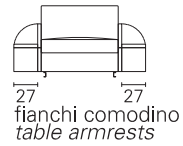
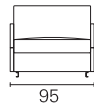
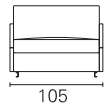
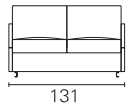
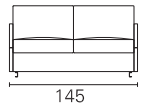
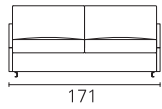
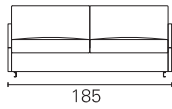
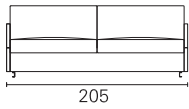

BK 119

Vignelli Design

Meccanismo
Mechanism
Cube

Materasso
Mattress
Boss

Misura
Size

- cm 176 x 195
- cm 156 x 195
- cm 142 x 195
- cm 116 x 195
- cm 102 x 195
- cm 77 x 195
- cm 67 x 195

- 205
- 185
- 171
- 145
- 131
- 105
- 95



BK 117



BK 118



BK 119



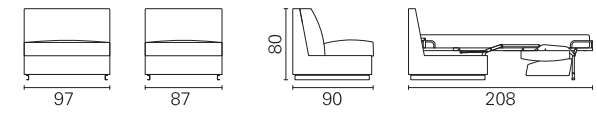

BK 117

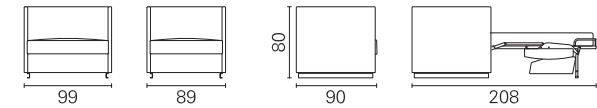

BK 118

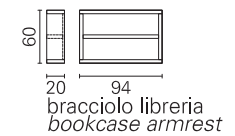
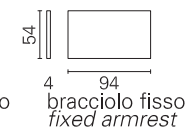
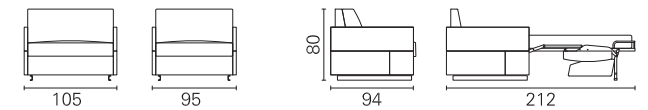

BK 119

BK ITALIA

Convertibles

Trasformabile

BK 119 B

Vignelli Design



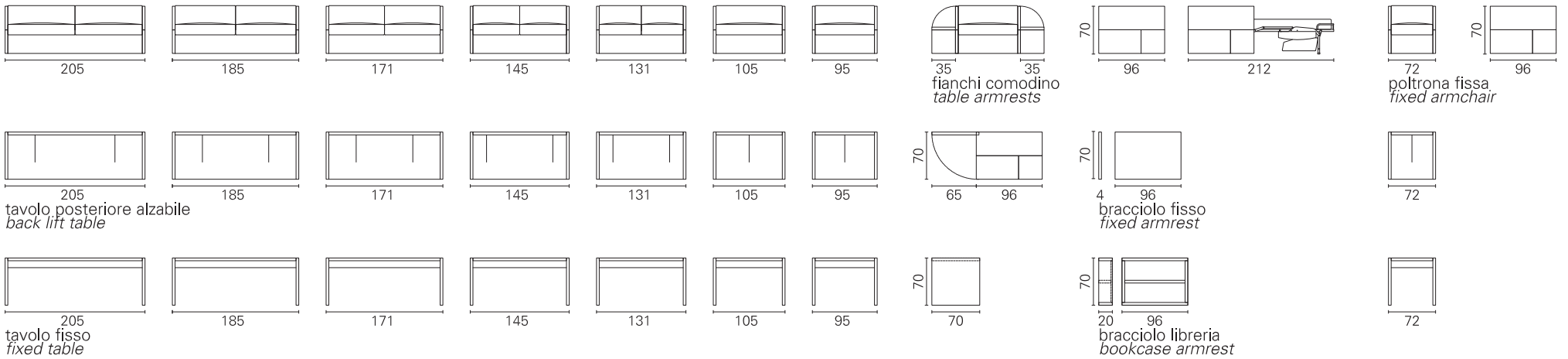

BK 119 B
Vignelli Design

Meccanismo
Mechanism
Cube

Materasso
Mattress
Boss

Misura
Size

cm 176 x 195	205
cm 156 x 195	185
cm 142 x 195	171
cm 116 x 195	145
cm 102 x 195	131
cm 77 x 195	105
cm 67 x 195	95

BK ITALIA

Convertibles

Trasformabile

BK 119 B

Vignelli Design



Rigido e soffice, contenitore e contenuto.

Linearità nelle forme pulite, come nella tradizione dell'intera collezione, misure controllate e regolari, proprie di un cubo. Il modello BK 119 B gioca sull'abbinamento del legno naturale in diverse essenze naturali (wengè, rovere, noce e ciliegio) ai tessuti rigorosamente made in Italy.

La parte rigida, che contiene lo schienale e la seduta, si arricchisce di inaspettati tavolini che si ricavano abbassando i braccioli.

Due pratici portaoggetti di giorno diventano, durante la notte, a letto aperto, due utili comodini.

In alternativa il bracciolo può anche essere una piccola e pratica libreria.

Il divano inoltre può essere dotato di un tavolo che si integra perfettamente alla struttura del divano, lo arricchisce e ne

completa le funzionalità: tavolo fisso e indipendente per l'uso quotidiano o tavolo a scomparsa nella parte posteriore dello schienale.

Tutti i sistemi di movimento (divano-letto, bracciolo-tavolino, schienale-tavolo) sono studiati, progettati e prodotti nei laboratori BK.

In un'unica isola compatta, coerente e lineare, convivono tre elementi essenziali dell'arredamento: letto, divano e tavolo.

Il massimo comfort nel riposo è garantito dall'utilizzo di una rete a doghe di faggio disponibile in 7 diverse larghezze (dalla più piccola che misura cm. 70 x 200 alla king size di cm. 180 x 200) e di un materasso a molle dall'altezza effettiva di cm. 15.

Le misure particolarmente contenute dell'ingombro esterno (p. cm. 93, h. cm. 70), unite all'eccezionale comfort del materasso, fanno del modello BK 119 B un oggetto di arredo

che va incontro alle richieste non solo del mercato privato e del contract alberghiero ma anche delle cliniche ospedaliere che necessitano di soluzioni veloci e comode.





Tavolo fisso / Fixed table



Tavolo posteriore alzabile / Back liftable



Rigid and soft, container and contained.

Contrasts with the new BK 119 B convertible.

Clean, straight lines, as is the tradition in the entire collection, limited, regular measurements, like a cube.

This model plays with the combination of wood (wengè, oak, walnut, cherry in natural veneered panels) and fabric, all Made in Italy.

The soft part contains the back support and the seat, which are fitted with hidden tables that can be disclosed by lowering the arms.

Two handy daytime item holders that become two bedside tables at night.

Armrest could be used also as a small and practical bookcase.

The convertible BK 119 B is endowed with a table perfectly integrated to the structure of the sofa, enriching it and

completing the functionalities: fixed and separate table for everyday use or lift table, hidden in the back part of the sofa.

All mechanisms (sofa-bed, armrest-bedside table, backrest-table) are designed and manufactured in BK's departments.

In a unique compact, coherent and linear island, three essential elements of the furnishing cohabit together: bed, sofa and table.

Maximum comfort for rest is guaranteed by the wooden stave base, available in 7 different widths (from the smallest 70x200 cm, to the king size bed 180x200 cm) and a high spring mattress 15 cm.

The limited measurements of the outer volume (d. 93 cm x h. 70 cm) together with the exceptional comfort of the mattress make the BK 119 B a piece of furniture that meets not only the

requirements of the private and hotel contract markets, but also hospital and clinic requirements that need fast, comfortable solutions.





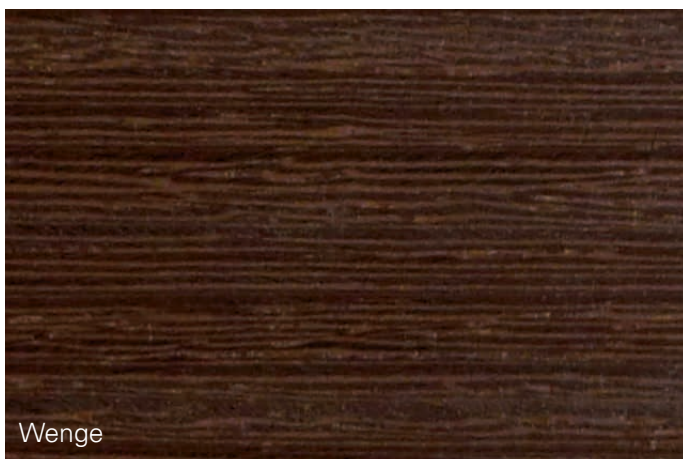

Wenge



Noce / Walnut



Rovere / Oak



Ciliegio / Cherry

Essenze

Tutti gli accessori in legno sono realizzati in pannelli tamburati e impiallacciati con essenze naturali.

Questo tipo di struttura li rende robusti ma leggeri e quindi facili da muovere.

L'impiallacciatura è realizzata in diverse essenze naturali, ricoprendo cioè la struttura con sottili pannelli di vera essenza (wengè, rovere, noce e ciliegio).

La finitura superficiale è realizzata con un impregnante trasparente a cera a base d'acqua che conferisce uno strato di protezione senza alterare l'elasticità e la porosità della fibra del legno.

L'effetto alla vista e al tatto è quello di vero legno naturale a poro aperto.

Wood natural essences

All the wood details are made of sandwich natural veneered panels in natural wood.

This type of structure is strong but light, easily to move.

Panels can be veneered in natural wengè, oak, walnut or cherry.

The surface finish is made with a transparent impregnating water-based wax which gives a protection without changing the elasticity and porosity of the wood fiber.

The effect to the eye and to the touch is that of real wood with open pores.



BK ITALIA

Convertibles

Trasformabile
BK 123 Cesta

Vittorio Prato design



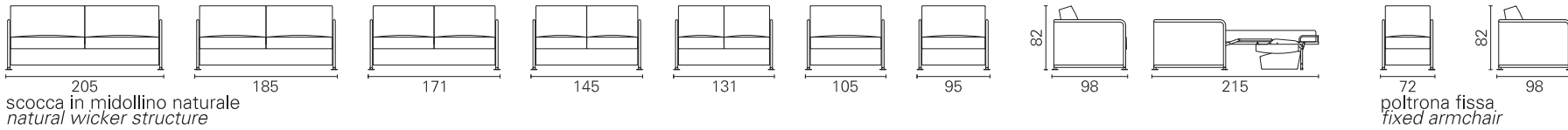

BK 123 Cesta

Vittorio Prato design

Meccanismo
Mechanism
Cube

Materasso
Mattress
Boss

Misura
Size

cm 176 x 195
cm 156 x 195
cm 142 x 195
cm 116 x 195
cm 102 x 195
cm 77 x 195
cm 67 x 195

205
185
171
145
131
105
95

BK ITALIA

Convertibles

Trasformabile
BK 123 Nastro

Vittorio Prato design



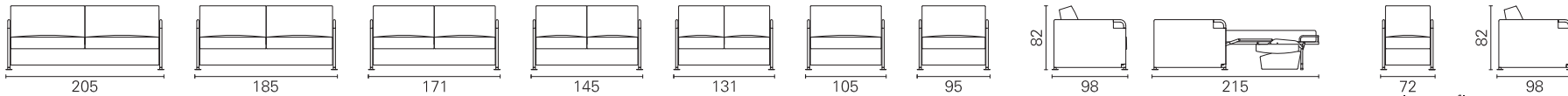

scocca in nastro di lino naturale
interwined linen ribbons structure

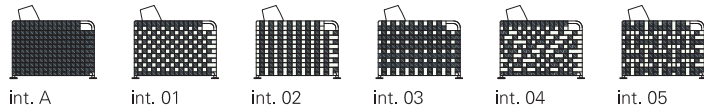

int. B
scocca in nastro di cotone naturale
interwined cotton ribbons structure

72
poltrona fissa
fixed armchair

BK 123 Nastro

Vittorio Prato design

Meccanismo
Mechanism
Cube

Materasso
Mattress
Boss

Misura
Size

cm 176 x 195	205
cm 156 x 195	185
cm 142 x 195	171
cm 116 x 195	145
cm 102 x 195	131
cm 77 x 195	105
cm 67 x 195	95

BK ITALIA

Convertibles

Trasformabile
BK 123 Tessuto

Vittorio Prato design



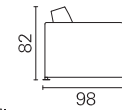
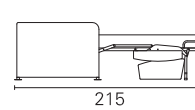
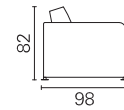
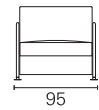
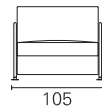
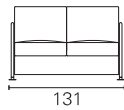
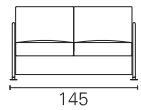
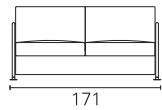
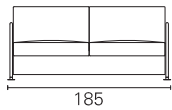
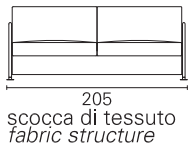

poltrona fissa
fixed armchair

BK 123 Tessuto

Vittorio Prato design

Meccanismo
Mechanism
Cube

Materasso
Mattress
Boss

Misura
Size

cm 176 x 195
cm 156 x 195
cm 142 x 195
cm 116 x 195
cm 102 x 195
cm 77 x 195
cm 67 x 195

205
185
171
145
131
105
95

BK ITALIA

Convertibles

BK 123
Dettagli / Details

Vittorio Prato design





BK 123 CESTA

Sistema di divani e poltrone aggregabili in varie combinazioni, trasformabili con semplicità in letti con elevate prestazioni d'uso e di sicuro comfort. Rete a doghe di multistrato di faggio evaporato. Struttura in tubolare di acciaio elettrosaldato e verniciato a fuoco in vari colori, rivestimento della struttura in midollino naturale intrecciato a mano come nella tradizione della produzione delle ceste.

System of sofas and armchairs that can be put together in various combinations, easily converted into beds with high performances and safe comfort. Slatted bed base in evaporated beech plywood.

Frame in electro-welded steel tubes, fire-painted in various colours, frame lined with hand-woven natural wicker, like in the basket-making tradition.



BK 123 NASTRO

Il sistema si arricchisce di altre versioni estetiche e tecniche, secondo un concetto di contenitore nel quale inserire ed estrarre i meccanismi dei letti e i cuscini dei divani.

Struttura rivestita con intreccio di nastri colorati di lino e cotone alti 5 cm. Intreccio che può generare un'infinità di soluzioni, anche sorprendenti.

The system is enriched with additional looks and technical versions, according to the concept of a container in which the bed mechanisms and sofa cushions can be put in and taken out.

Frame lined with intertwined coloured linen and cotton ribbons, 5 cm high. Intertwining that produces countless solutions, even surprising ones.



BK 123 TESSUTO

Un'ulteriore proposta che arricchisce il sistema, un progetto in evoluzione sempre disponibile a corrispondere con facilità alle sollecitazioni più fantasiose e imprevedibili della creatività, del design, delle mode, di ogni voglia e di ogni necessità.

Struttura in tubolare di acciaio, imbottito e rivestito con fodere in tessuto facilmente sfoderabili, confezionate con ogni tipo di tessuto a catalogo o fornito dai clienti.

An additional product that enriches the system, an evolving project that is always on hand to easily satisfy the most imaginative and unpredictable creative, design and fashion stimuli, as well as any whims and needs.

Frame in steel tubes, padded and lined with fabric covers that can be easily removed, made with all kinds of fabric, available in the catalogue or supplied by the customer.

BK ITALIA

Convertibles

Trasformabile
BK 124

Vittorio Prato design



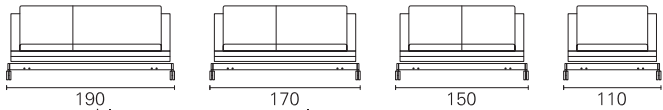

190
struttura bianca - rossa - antracite
white - red - anthracite structure

170

150

110

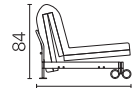
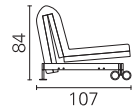

107
testiera
headboard

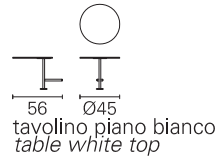
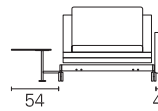
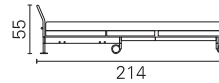

56 Ø45
tavolino piano bianco
table white top

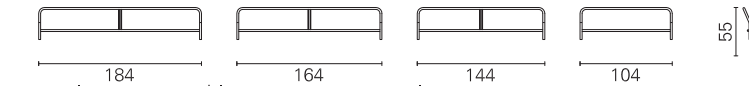

184 164 144 104 55
testiera struttura bianca - rossa - antracite
headboard white - red - anthracite structure

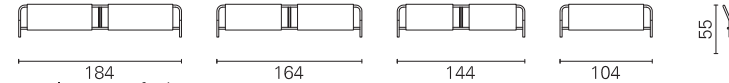

184 164 144 104 55
testiera con fodera
headboard with cover

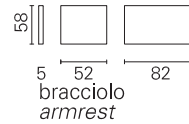

5 52 82 58
bracciolo
armrest



70-80 50
guanciale
pillow

BK 124

Vittorio Prato design

Meccanismo
Mechanism
BK 124

Materasso
Mattress
BK 124

Misura
Size

cm 160 x 200
cm 140 x 200
cm 120 x 200
cm 80 x 200

190
170
150
110

**BK 124**

Un prodotto essenziale, un prodotto di industrial design. Telaio metallico con molleggio di doghe di faggio multistrato, imbottito e rivestito in tessuto sfoderabile, bordi rinforzati con speciali nastri. Elementi strutturali in profilato di acciaio verniciato in vari colori a fuoco con polveri epossidiche. Materasso solidale alla struttura, ripiegato in tre con meccanismo telescopico ad alta resistenza e portanza, azionato su cuscinetti a sfera. Molteplici le possibili soluzioni dimensionali e funzionali con possibilità di aggregazione di accessori per soddisfare le più svariate esigenze d'uso. Accessori quali spalliere con o senza rivestimento imbottito, maniglioni, braccioli, tavolini vincolabili alla struttura di diverse dimensioni e colori. Cuscini per creare l'assetto ergonomico desiderato e contenere guanciali e pigiama.

A basic product, an industrial design product. Metal frame with springing in beech plywood, padded and lined with removable fabric, and edges reinforced with special ribbons. Structural elements in steel section, fire-painted in various colours with epoxy powders. Mattress joined to the frame, folded in three parts with telescopic mechanism featuring high-resistance and carrying capacity, operated on ball bearings. Multiple dimensional and functional solutions with the possibility to add accessories in order to meet a wide range of needs. Accessories such as backrests with or without padded lining, large handles, armrests, tables in different sizes and colours that can be bound to the frame. Cushions to create the desired ergonomic layout and to hold pillows and pyjamas.



BK ITALIA

Convertibles

Trasformabile

BK 125

Vittorio Prato design



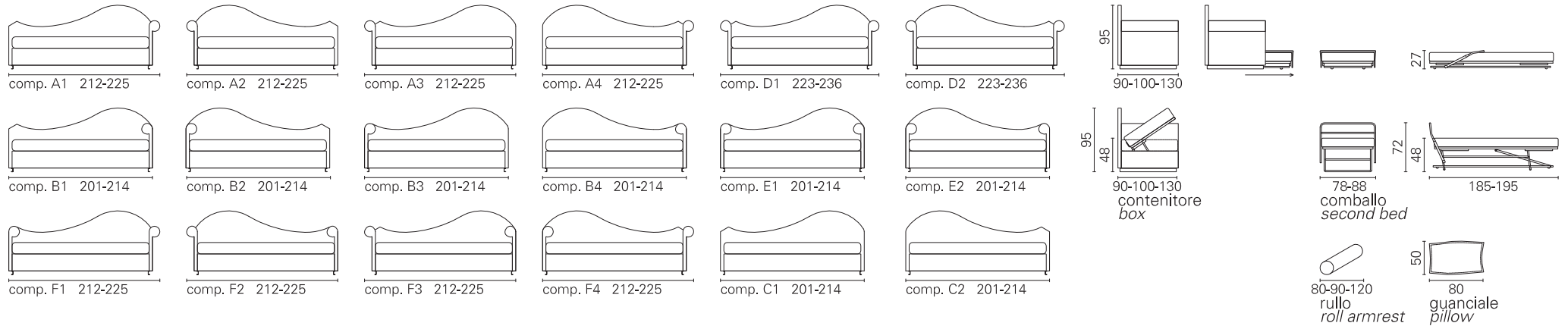

BK 125

Vittorio Prato design

Meccanismo
Mechanism
Angelo

Meccanismo rete inferiore
Second bed Mechanism
Comballo

Materasso
Mattress
Caravaggio superiore

cm 120 x 200 - cm 120 x 187
cm 90 x 200 - cm 90 x 187
cm 80 x 200 - cm 80 x 187

Materasso
Mattress
Caravaggio inferiore

cm 75 x 195
cm 75 x 185
cm 85 x 195
cm 85 x 185

**BK 125**

Prodotto proposto come sistema, permette una molteplicità di soluzioni con pochi elementi funzionalmente e tecnicamente mirati.

Matrice del sistema è il letto singolo, la struttura del letto contiene il molleggio in doghe di faggio multistrato e gli elementi per il fissaggio degli elementi accessori che generano molteplici soluzioni per ogni necessità d'uso o di gusto estetico. La struttura base è progettata per accogliere sempre e per ogni tipo di configurazione il secondo letto estraibile, predisposto con le stesse caratteristiche tecniche e funzionali del letto strutturale. Il secondo letto è facilmente configurabile come allestimento estetico con il letto strutturale con semplici e rapidi interventi. La struttura è realizzata in profilato di acciaio verniciato e opportunamente lavorato.

Struttura rivestita interamente in tessuto e completata con i braccioli accessorio che consentono diverse soluzioni formali e compositive. Il disegno dei braccioli si armonizza alla perfezione con l'andamento delle curve della spalliera imbottita e rivestita in tessuto, secondo un gusto classico e romantico, interpretato in chiave contemporanea. I rivestimenti sono tutti sfoderabili e lavabili, possono essere realizzati con tutte le varianti di tessuto a catalogo e con tessuto cliente.

Product offered as a system that allows for multiple solutions with a few functionally and technically targeted elements.

The matrix of the system is represented by the bed, whose frame contains a springing in beech plywood slats as well as the elements to secure the accessories capable of generating multiple solutions to satisfy all kinds of needs or aesthetic tastes.

The basic frame is designed to always welcome, for all types of configurations, the second pull-out bed, set up with the same technical and functional features as the structural bed.

The second bed can be easily configured as an aesthetic fitting with the structural bed through simple and quick operations.

The frame is made in steel section, varnished and suitably processed. Frame lined entirely with fabric and completed with accessory armrests that allow different formal and compositional solutions. The shape of the armrests is perfectly in keeping with the curves of the padded backrest lined with fabric, according to a classic and romantic taste revisited in contemporary key.

All linings are removable and washable, and they can be made using all kinds of fabrics available in the catalogue as well as fabrics supplied by the customer.



BK ITALIA

Convertibles

**Trasformabile
BK 126 Special**



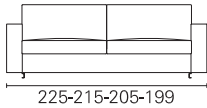

225-215-205-199
br/arm 17-12-7-4

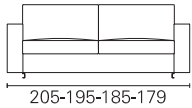

205-195-185-179
br/arm 17-12-7-4

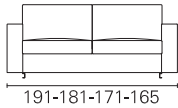

191-181-171-165
br/arm 17-12-7-4

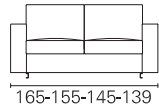

165-155-145-139
br/arm 17-12-7-4

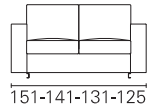

151-141-131-125
br/arm 17-12-7-4

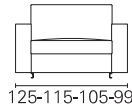

125-115-105-99
br/arm 17-12-7-4

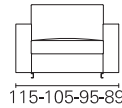

115-105-95-89
br/arm 17-12-7-4

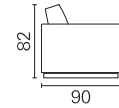

82
90

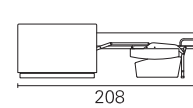

208

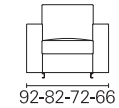

92-82-72-66
br/arm 17-12-7-4

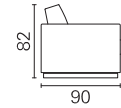

82
90

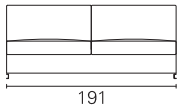

191

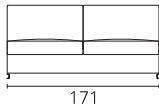

171

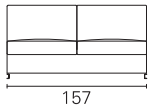

157

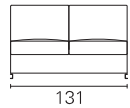

131

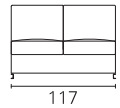

117

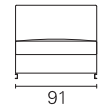

91

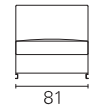

81

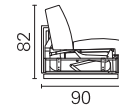

82
90

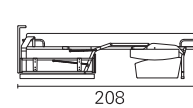

208

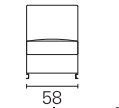

58

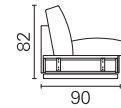

82
90

poltrona fissa
fixed armchair

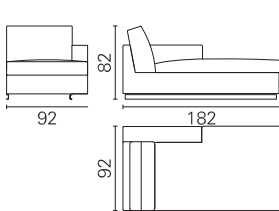

92
182
92

chaise longue

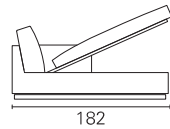

182

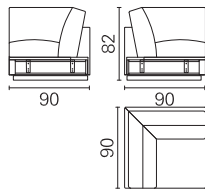

82
90
90
90

angolo - corner

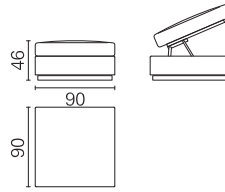

46
90
90

pouf

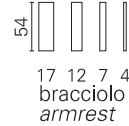

54
17 12 7 4
bracciolo
armrest

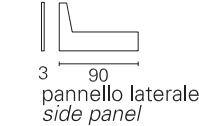

3 90
pannello laterale
side panel

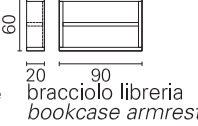

60
20 90
bracciolo libreria
bookcase armrest

BK 126 Special

Meccanismo
Mechanism
Cube

Materasso
Mattress
Boss

Misura
Size

cm 176 x 195
cm 156 x 195
cm 142 x 195
cm 116 x 195
cm 102 x 195
cm 77 x 195
cm 67 x 195

225
205
191
165
151
125
115

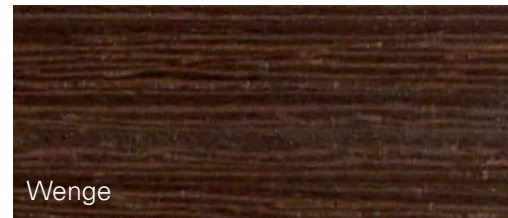

Wenge

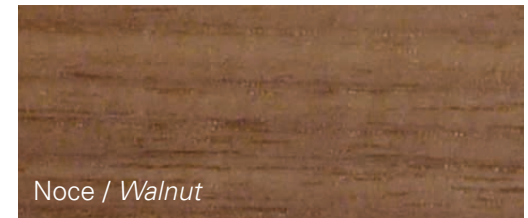

Noce / Walnut

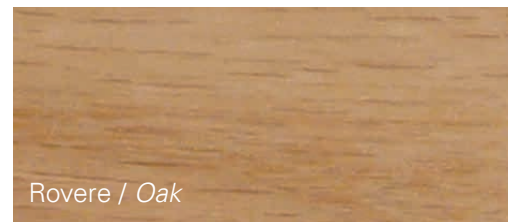

Rovere / Oak

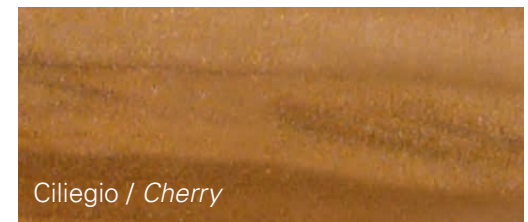

Ciliegio / Cherry



Wenge



Noce / Walnut



Rovere / Oak

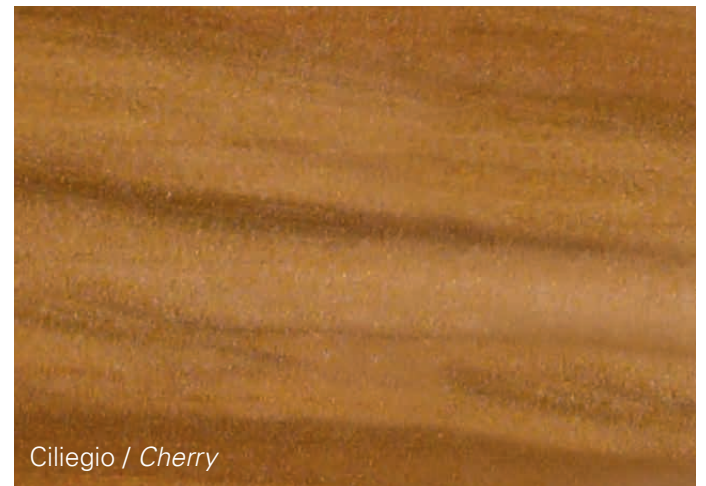

Ciliegio / Cherry

BK ITALIA

Convertibles

**Trasformabile
BK 126**



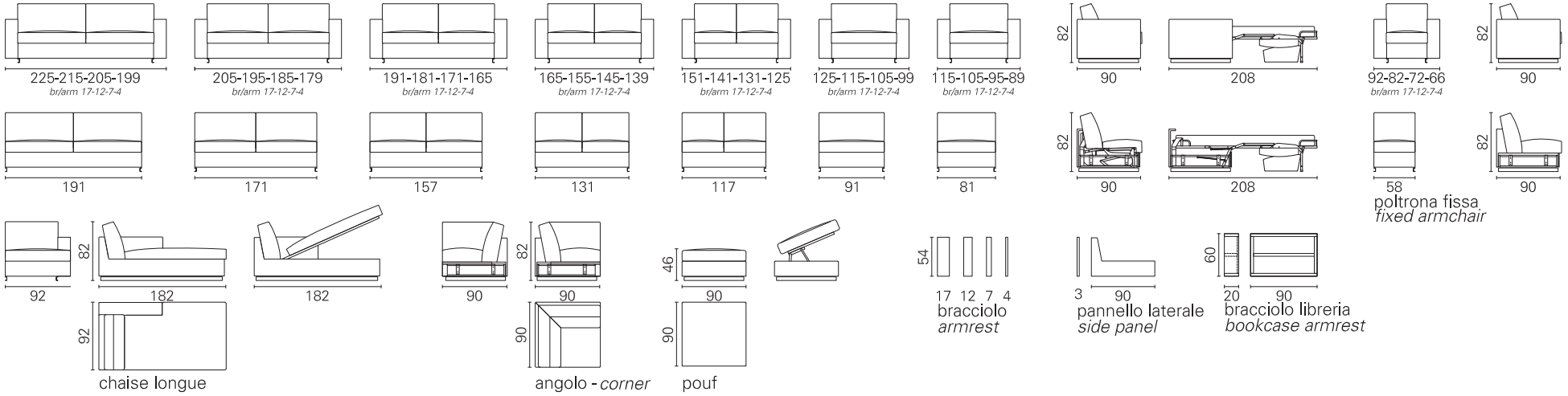

BK 126

Meccanismo
Mechanism
Cube

Materasso
Mattress
Boss

Misura
Size

cm 176 x 195	225
cm 156 x 195	205
cm 142 x 195	191
cm 116 x 195	165
cm 102 x 195	151
cm 77 x 195	125
cm 67 x 195	115

BK ITALIA

Convertibles

**Trasformabile
BK 127**



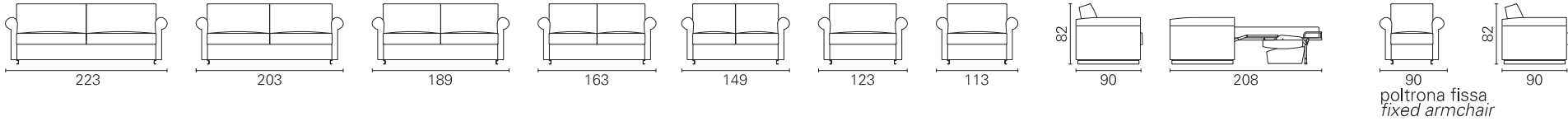

BK 127

Meccanismo
Mechanism
Cube

Materasso
Mattress
Boss

Misura
Size

cm 176 x 195
cm 156 x 195
cm 142 x 195
cm 116 x 195
cm 102 x 195
cm 77 x 195
cm 67 x 195

223
203
189
163
149
123
113

BK ITALIA

Convertibles

**Trasformabile
BK 128**



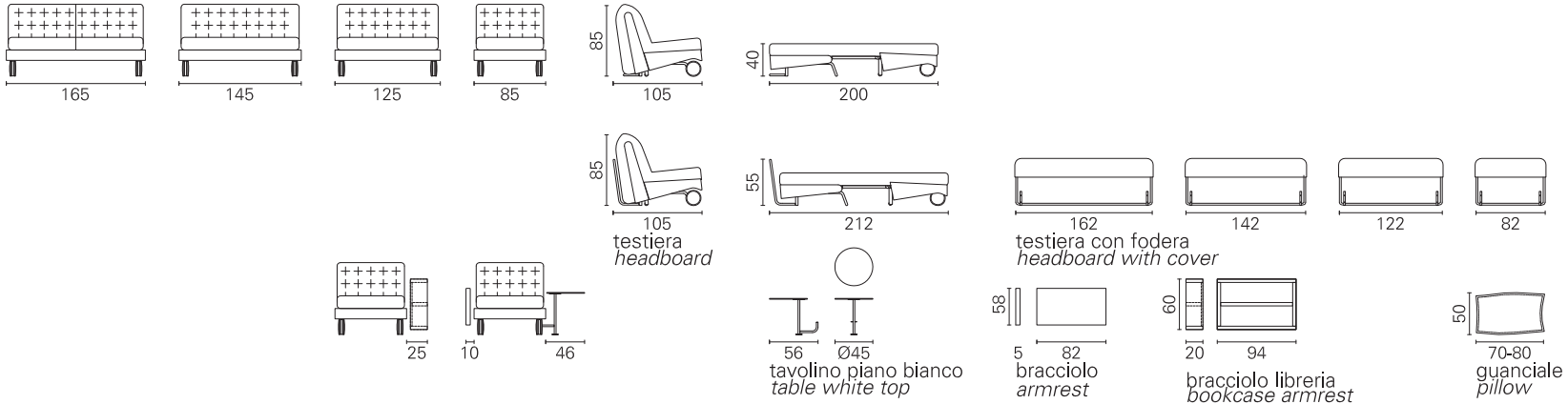

BK 128

Meccanismo
Mechanism
BK 128

Materasso
Mattress
Oasi

Misura
Size

cm 160 x 200
cm 140 x 200
cm 120 x 200
cm 80 x 200

165
145
125
85

BK ITALIA

Convertibles

BK 128
Dettagli / Details





BK ITALIA

Convertibles

**Trasformabile
BK 129**



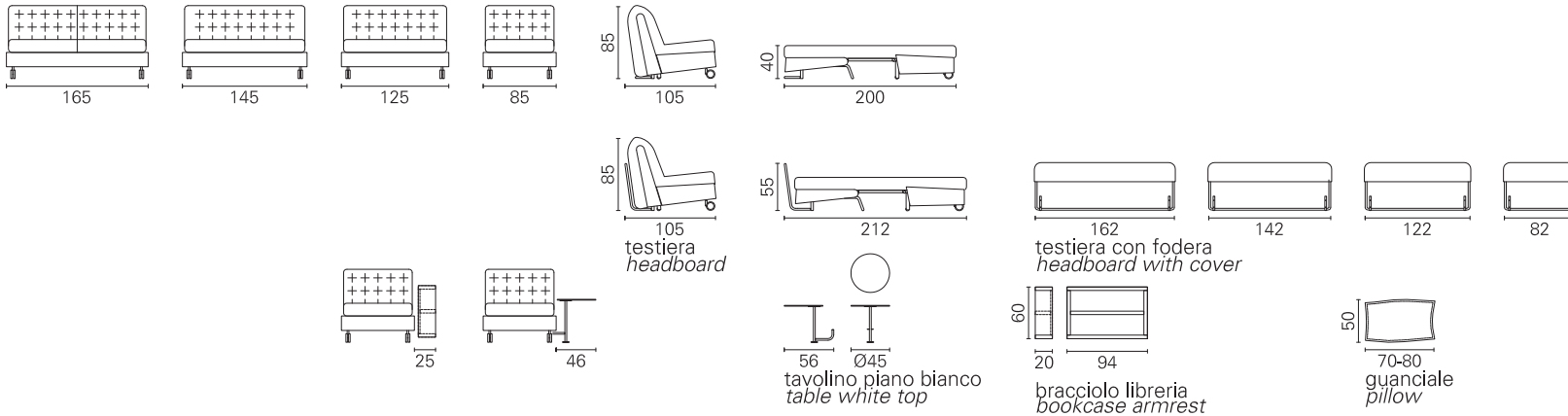

BK 129

Meccanismo
Mechanism
BK 128

Materasso
Mattress
Oasi

Misura
Size

cm 160 x 200
cm 140 x 200
cm 120 x 200
cm 80 x 200

165
145
125
85

BK ITALIA

Convertibles

BK 129
Varianti / Variants



BK 129 B senza ruote / *without wheels*



BK 129 Modern



BK 129 Vintage



BK 129 Classic

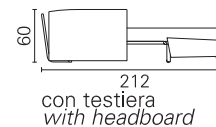
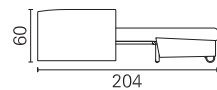
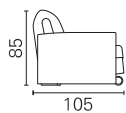
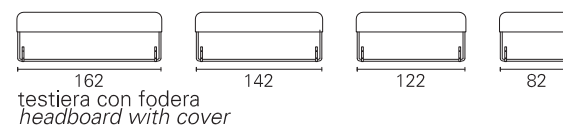
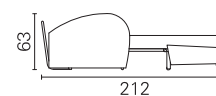
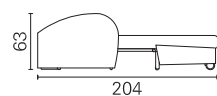
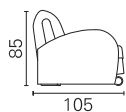
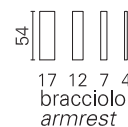
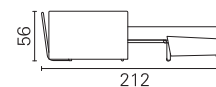
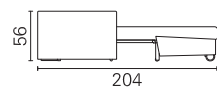
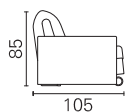
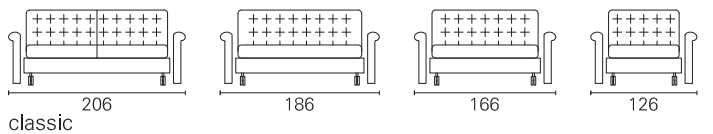
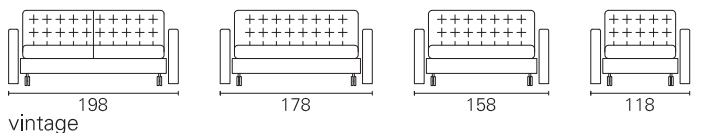
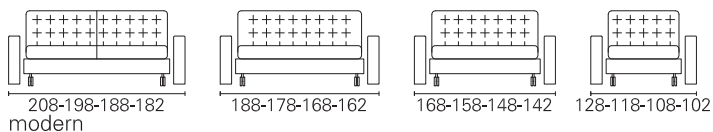

BK 129

Meccanismo
Mechanism
BK 128

Materasso
Mattress
Oasi

Modern Vintage Classic

cm 160 x 200	210	192	200
cm 140 x 200	190	172	180
cm 120 x 200	170	152	160
cm 80 x 200	130	112	120





BK ITALIA

Convertibles

Materassi
Mattresses



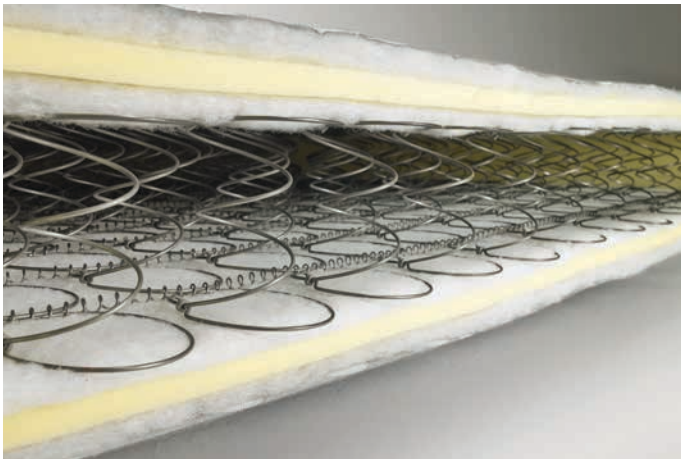

Il materasso a molle Bonnell è la tipologia più diffusa al mondo

Caratteristiche e utilizzo: Materasso robusto, durevole, rigido, traspirante, consigliato a chi lascia il divano chiuso per lunghi periodi. La struttura tradizionale delle molle legate tra loro da una spirale in acciaio permette la piegatura del materasso senza che sia danneggiato. La struttura a carcassa risulta per sua natura anallergica, atossica, antimicrobica e igienica oltre a conferire al materasso massima traspirabilità e indeformabilità.

Materiali: Il materasso è composto da una carcassa di filo d'acciaio fosfatato e temprato Ø 2.2 mm, rivestita con feltri senza fenoli, ovatte in fibra, lastre in poliuretano espanso a densità differenziate e tessuto di rivestimento in filo di poliestere e fibra modacrilica. Tutti i materiali sono ignifughi e i materassi sono omologati in classe di reazione al fuoco 1IM secondo le rigide procedure del Ministero degli Interni italiano.

The spring Bonnell mattress is the most common in the world

Features and use: strong, durable, rigid and breathable mattress, recommended for those who leave the sofa closed for long periods. The traditional structure of the springs linked together by a steel spiral allows the folding of the mattress without damage. This structure is by his nature hypoallergenic, non-toxic, antimicrobial and healthy and moreover gives breathability and rigidity to the mattress.

Materials: Spring Bonnell mattress is made of a phosphatized and tempered steel wire frame Ø 2.2 mm, covered with free phenol felts, wadding fiber, foam with different density and covering fabric in polyester and modacrylic fiber. All materials are fire retardant and moreover mattresses are 1 IM fire reaction class in accordance with the strict laws of Italian rules.

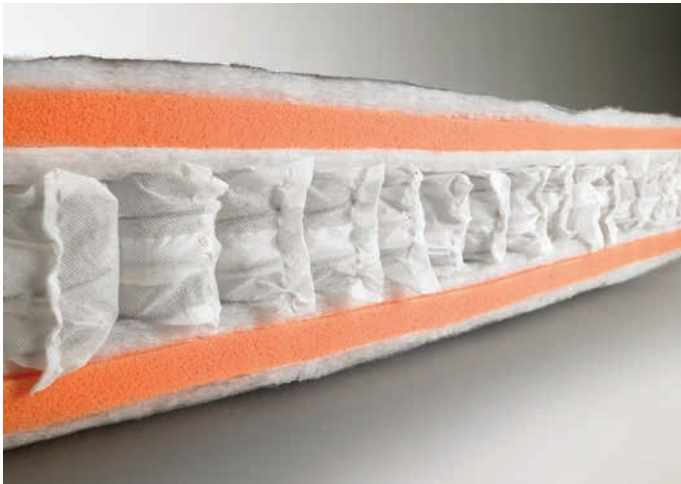

Il materasso a molle insacchettate indipendenti è la tecnologia a molle di ultima generazione

Caratteristiche e utilizzo: Materasso elastico, ergonomico, traspirante, consigliato per l'uso quotidiano e per persone non troppo robuste. La struttura, costituita da molle indipendenti, rivestite singolarmente e successivamente assemblate, rende il materasso flessibile, morbido e adattabile ad ogni tipo di sollecitazione. Le molle sono di diametro inferiore alle Bonnell e quindi in numero superiore.

Materiali: Il materasso è composto da una carcassa di molle in acciaio insacchettate e indipendenti rivestita con feltri senza fenoli, ovatte in fibra, lastre in poliuretano espanso a densità differenziate e tessuto di rivestimento in filo di poliestere e fibra modacrilica. Tutti i materiali sono ignifughi e i materassi sono omologati in classe di reazione al fuoco 1IM secondo le rigide procedure del Ministero degli Interni italiano.

The independent pocket spring mattress is the latest generation of spring mattresses technology

Features and use: elastic, ergonomic and breathable mattress, recommended for everyday use and for people not too heavy. The structure, made up of independent pocket springs, coated individually and then assembled, makes the mattress flexible, soft and adaptable to any type of stress. These springs are smaller than Bonnell, and then in higher number.

Materials: The mattress is made by a structure of independent pocket steel springs covered covered with free phenol felts, wadding fiber, foam with different density and covering fabric in polyester and modacrylic fiber. All materials are fire retardant and moreover mattresses are 1 IM fire reaction class in accordance with the strict laws of Italian rules.



Il materasso a molle insacchettate con lastra in memory combina ed esalta due soluzioni di alta tecnologia

Caratteristiche e utilizzo: Materasso ergonomico ad elevate prestazioni di confort, consigliato per clienti particolarmente esigenti nella qualità del dormire ma non troppo robusti. La struttura, costituita da molle indipendenti, rende il materasso flessibile, morbido e adattabile ad ogni tipo di sollecitazione. La lastra in schiuma visco-elastica nella parte superiore esalta le caratteristiche della struttura e aggiunge l'effetto "memoria" al materasso che, sollecitato dal peso del corpo, si automodella ritornando poi alla forma originaria.

Materiali: Il materasso è composto da una carcassa di molle in acciaio insacchettate e indipendenti rivestita con feltri senza fenoli, ovatte in fibra, lastre in poliuretano espanso a densità differenziate, nella parte superiore, lastra in schiuma visco-elastica. Il tessuto di rivestimento è in filo di poliestere e fibra modacrilica.

The independent pocket spring mattress with memory foam combines and enhances two high-tech solutions

Features and use: ergonomic mattress with high-performance comfort, recommended for particularly demanding customers about the quality of sleep, but not for too heavy people. The structure, made up of independent pocket springs, makes the mattress flexible, soft and adaptable to any type of stress. The viscoelastic layer gives to the mattress a "memory effect": the higher-density memory foam softens in reaction to body heat, allowing it to mold to a warm body in a few minutes.

Materials: The mattress is made by a structure of independent pocket steel springs covered with free phenol felts, wadding fiber, foam with different density and covering fabric in polyester and modacrylic fiber. In the upper part there is a polyurethane viscoelastic foam layer.

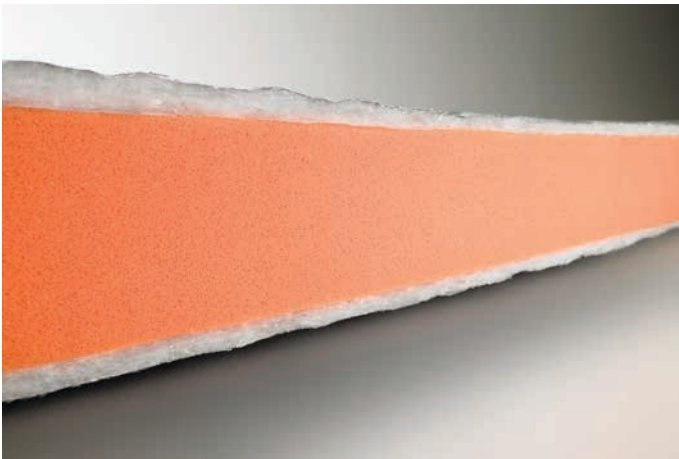

Il materasso in poliuretano indeformabile ad elevato confort è un ottimo compromesso che combina adattabilità e sostegno.

Caratteristiche e utilizzo: Materasso elastico, con buona adattabilità, consigliato per l'uso quotidiano, per i climi freddi e per chi non ha difficoltà nella regolazione termica (il poliuretano è un ottimo isolante termico). La struttura è costituita da una lastra in poliuretano ad alta densità che garantisce ottimo sostegno ma è al tempo stesso morbido e accogliente.

Materiali: Il materasso è composto da un'anima di poliuretano espanso ignifugo senza C.F.C. di **densità 40 kg/mc** indeformabile, rivestito da una falda di fibra termolegata. Il tessuto di rivestimento è in filo di poliestere e fibra modacrilica. Tutti i materiali sono ignifughi e i materassi sono omologati in classe di reazione al fuoco 1IM secondo le rigide procedure del Ministero degli Interni italiano.

The polyurethane foam mattress - high confort is a good compromise that combines adaptability and support.

Features and use: elastic mattress, with good adaptability, recommended for everyday use, for cold climates and for those who have not difficulty in thermal regulation (polyurethane is an excellent thermal insulator). The structure is made from a layer of high density polyurethane that ensures good support but at the same time soft and comfortable.

Materials: Polyurethane mattress is made by a polyurethane foam core with no C.F.C., with a **density of 40 kg/mc** non-deformable, covered with a heat sealed layer. The covering fabric is in polyester and modacrylic fiber. All materials are fire retardant and moreover mattresses are 1 IM fire reaction class in accordance with the strict laws of Italian rules.



Il materasso in memory sfrutta al meglio le caratteristiche ergonomiche del poliuretano visco-elastico

Caratteristiche e utilizzo: Materasso ergonomico ad ottime prestazioni di confort, consigliato per l'uso quotidiano.

La struttura è costituita da due lastre in poliuretano: una ad alta densità che garantisce sostegno, e una, nella parte superiore, in schiuma visco-elastica che conferisce al materasso l'effetto "memoria", poiché sollecitato dal peso del corpo si automodella ritornando poi alla forma originaria.

Materiali: Il materasso è composto da un'anima di poliuretano espanso ignifugo senza C.F.C. di **densità 40 kg/mc** indeformabile combinata con una lastra in schiuma visco-elastica nella parte superiore. Tutti i materiali sono ignifughi e i materassi sono omologati in classe di reazione al fuoco 1IM secondo le rigide procedure del Ministero degli Interni italiano.

Memory foam mattress takes full advantage of the ergonomic features of the visco-elastic

Features and use: Ergonomic mattress with impressive performance of comfort, recommended for everyday use.

The structure consists of two layers of polyurethane: one in a high density which ensures support, and, in the upper part, the visco-elastic foam that gives the "memory effect": higher-density memory foam softens in reaction to body heat, allowing it to mold to a warm body in a few minutes.

Materials: Memory foam mattress is made by a polyurethane foam core with no C.F.C., with a **density of 40 kg/mc** non-deformable, combined with a polyurethane viscoelastic foam layer, and covered with a heat sealed layer. The covering fabric is in polyester and modacrylic fiber. All materials are fire retardant and moreover mattresses are 1 IM fire reaction class in accordance with the strict laws of Italian rules.

Materasso - Mattress

Modello - Model

Boss	BK 101, BK 102, BK 103, BK 104, BK 105, BK 106, BK 107, BK 108, BK 117, BK 118, BK 119, BK 119 B, BK 123, BK 126, BK 127
Matrix	BK 109
Retrò	BK 110, BK 111, BK 112
Caravaggio	BK 113, BK 114, BK 115, BK 125
Poufletto	BK 116 pouf, BK 116 poltrona
BK 124	BK 124
Oasi	BK 128, BK 129

**Cube****Sistema rete ortopedica tradizionale con doghe da cm 7**

In questo sistema sono presenti 2 liste di doghe di multistrato di faggio evaporato senza formaldeide, larghe cm. 7, il cui spessore varia da mm. 12 a mm. 8, a seconda della lunghezza. La curvatura verso l'alto permette una perfetta ergonomia.

Traditional orthopaedic bed base with 7 cm strip slats

In this System, we have two series of beechwood multi-ply slats vapour treated without formaldehyde. They are 7 cm wide and their thickness ranges from 12 mm to 8 mm, depending on the length. The upward bending allows a perfect ergonomics.

**Starlet****Sistema rete ortopedica tradizionale con doghe da cm 7,**

costituito da 2 liste di doghe di multistrato di faggio evaporato senza formaldeide, larghe cm. 7, il cui spessore varia da mm. 12 a mm. 8, a seconda della lunghezza. La curvatura verso l'alto permette una perfetta ergonomia. Sulla parte finale sono presenti delle cinghie elastiche, per garantire una adeguata soffici ta alla seduta del divano.

Traditional orthopaedic bed base with 7 cm strip slats,

consisted in two series of beechwood multi-ply slats vapour treated without formaldehyde. They are 7 cm wide and their thickness ranges from 12 mm to 8 mm, depending on the length. The upward bending allows a perfect ergonomics. On the terminal section there have been inserted elastic straps for a suitable softness when someone sits down.



BK 128

Sistema con telaio a scorrimento composto da una base fissa e una rete snodata in tubo quadro su cui sono montate le doghe in multistrato di faggio evaporato curvate verso l'alto. Il meccanismo è dotato di ruote o piedi anteriori ammortizzati con molle a gas a scomparsa che permettono alla rete di assumere la posizione ergonomica inclinata del divano e orizzontale del letto.

Framed sliding system consists in a fixed base and in a flexible, square-tubed frame with wooden staves fastened to it. The bed's base is made of multilayered staves in beech wood, whose convexity allows for perfect ergonomic properties. The mechanism is equipped with wheels or feet with hidden gas springs that allow the frame to get ergonomic position both as a sofa and as a bed.



Dettaglio meccanismi e doga / Mechanism details and slats

Rete ortopedica tradizionale formata da uno speciale profilo in tubo quadro cavato e raccordato ai vertici con scatole in lamiera sagomate BK. Le reti matrimoniali da 140/160/180 cm con traverso centrale in appoggio. Doghe curvate in multistrato di faggio evaporato da 7 cm, spessore da 8 a 12 mm, sezione ondulata con nervatura longitudinale tipo Welle, doga con maggior resistenza elastica e miglior respirabilità del materasso in appoggio.

Traditional orthopaedic bed base formed by a steel square-tubed profile with special BK connection plates in the corners. 140/160/180 cm double frames are equipped with central support. Multilayered convex slats in beech wood are 7 cm wide and thickness from 8 to 12 mm, waved section with longitudinal ribs called Welle. This singular shape gives to the slats more elastic strength and better breathability to the mattress.

Meccanismo - Mechanism

Modello - Model

Cube	BK 101, BK 102, BK 103, BK 107, BK 108, BK 117, BK 118, BK 119, BK 119 B, BK 123, BK 126, BK 127
Starlet	BK 104, BK 105, BK 106
Matrix	BK 109
Retrò	BK 110, BK 111, BK 112
Angelo e Comballo	BK 113, BK 114, BK 125
America e Comballo	BK 115
Poufletto	BK 116 pouf, BK 116 poltrona
BK 124	BK 124
BK 128	BK 128, BK 129

BK ITALIA

Convertibles

BK Group srl
Via Bergamo 66,
24047 Treviglio (BG) Italy
T+39 0363 48971
F+39 0363 45917

info@bkitalia.com
www.bkitalia.com